

REFURBISHING AIDS

Floor Inlet Extender

- ◆ Extends Hayward model SP1425 floor inlet fitting by 1/2".
- ◆ Pressure connected.

FIC-1, FIC-2, FIC-3, FIE-1, FIE-2, FIE-3, FIE-4
 \$17.15, \$9.95, \$7.35, \$14.67, \$17.05, \$17.05, \$12.10

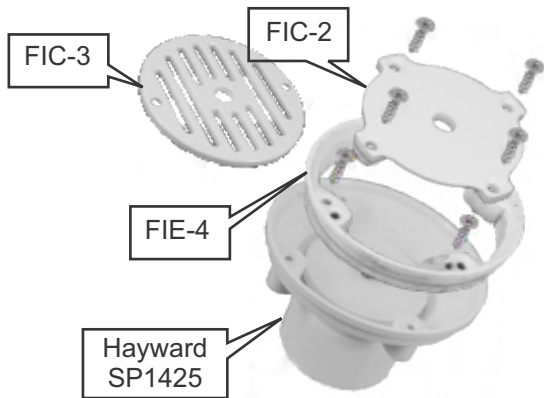

- ◆ Attaches firmly to present fitting.
- ◆ Eliminates the need to cut away surface material when preparing to resurface a pool.
- ◆ Maintains the ability to adjust the flow at each fitting by adjusting the deflector plate.
- ◆ Saves time.
- ◆ Results in a better job.
- ◆ Stackable if more extension is needed.
- ◆ Cost effective.
- ◆ PATENT PENDING

- ◆ Extends Sta Rite model 08417 floor inlet fitting by 1/2".
- ◆ Pressure connected.

- ◆ Extends Sta Rite model 08417 floor inlet fitting 7/8" to 1 1/4".
- ◆ Threaded connection.

- ◆ Extends Hayward model SP1425 floor inlet fitting by 3/4".
- ◆ Glued connection.

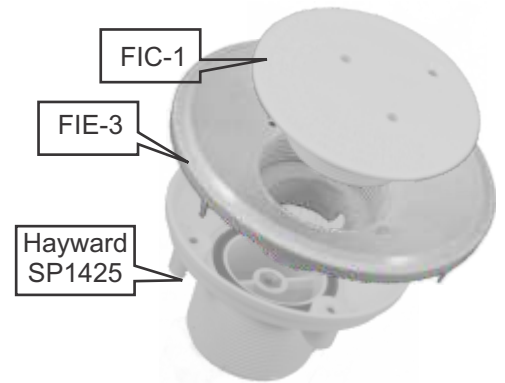
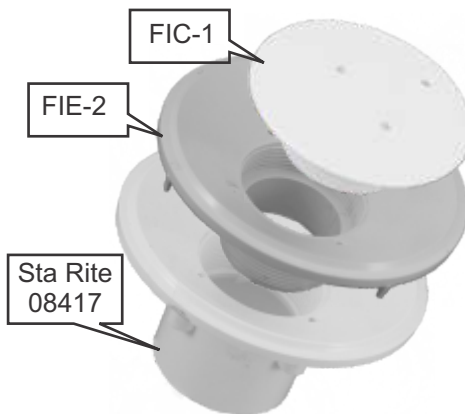
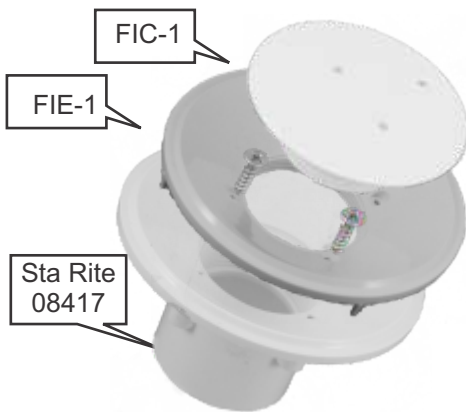

Floor Inlet Extender Kits

- ◆ Each Kit contains:
 One Floor Inlet Extender
 One Inlet Cover
 All the screws needed to install
- ◆ Each kit is poly bagged

FIK-1, FIK-2, FIK-3, FIK-4D, FIK-4G
 \$32.13, \$32.13, \$32.13, \$22.27, \$21.27

